



Technical Data

Intelligent Booster Pump - GBM 2200

Revision no.

Page:
1

Receiver

From

Company name
Respons. Department
Person in charge
Phone number
Fax no
E-mail address



Brand: Gol Pumps
Model: GBM 2200

Features:

- Permanent Magnet Motor With Variable Speed
- Energy Efficient
- Intelligent Operation
- Water pressure: intelligent pump control adjusts operation automatically
- Easy selection: one pump for all domestic boosting needs
- Easy installation: compact, all-in-one solution, plug-and-pump
- Easy to operate: user-friendly control panel

Dimensions (In):

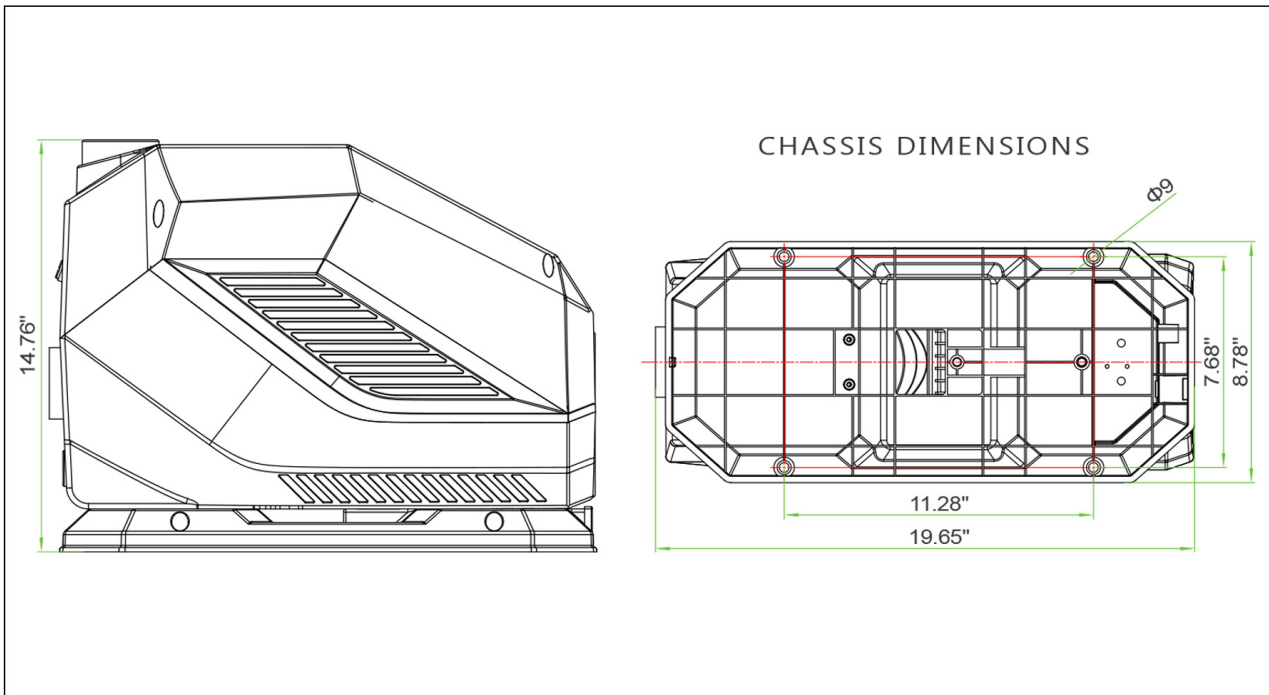

Inlet		Outlet	
mm	In.	mm	In.
50.8	2	50.8	2

Project

Project ID

Created by

Created on

Last update



Performance Curves

Intelligent Booster Pump - GBM 2200

Revision no.

Page:
2

Receiver

From

Company name
 Respons. Department
 Person in charge
 Phone number
 Fax no
 E-mail address

Model	Voltage	Frequency	Power		Max. Flow	Max. Head	Rated Flow	Rated Head
	V	Hz	kW	hp	GPM	ft	GPM	ft
GBM 2200	220 - 1Ph	50/60	2.2	3	82	230	35	161

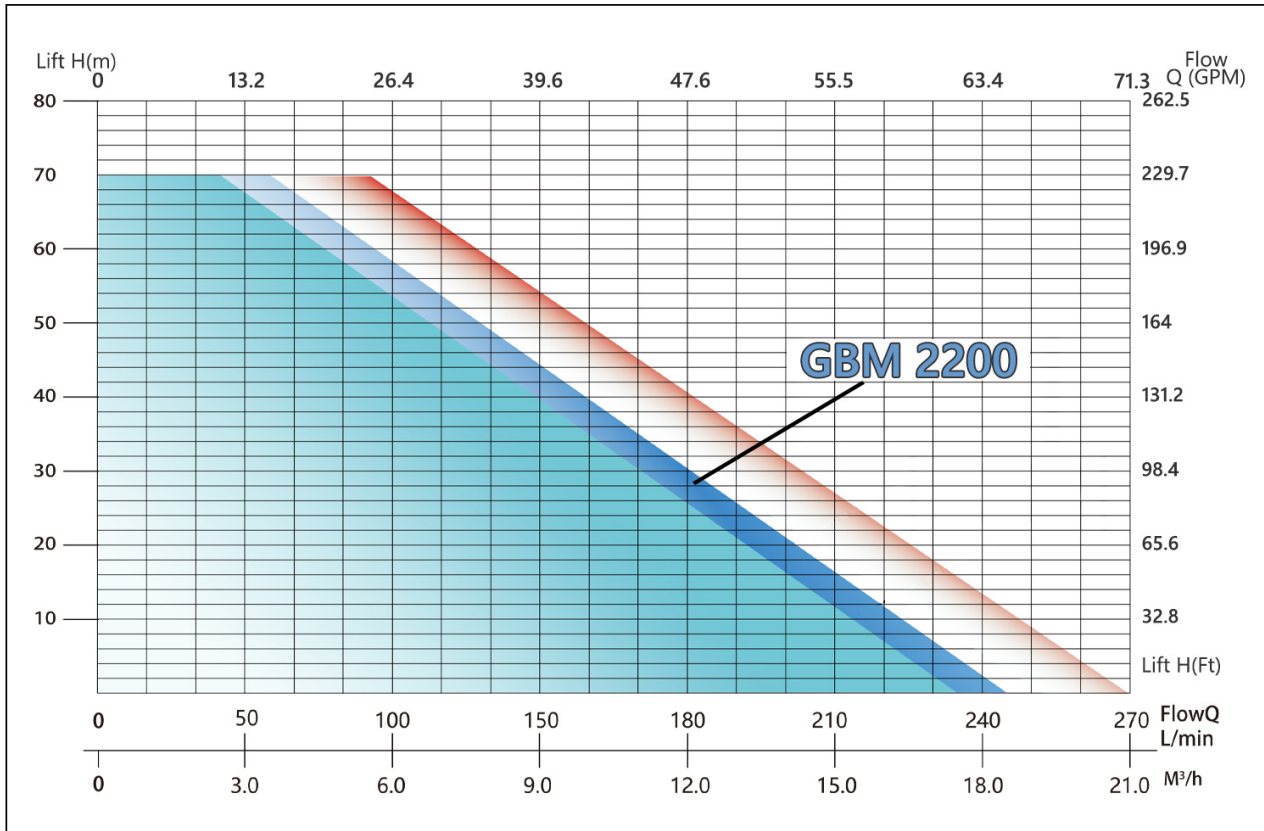

Project	Project ID	Created by	Created on	Last update
---------	------------	------------	------------	-------------



Parts List

Intelligent Booster Pump - GBM 2200

Revision no. _____
Page: 3

	Receiver	From
Company name		
Respons. Department		
Person in charge		
Phone number		
Fax no		
E-mail address		

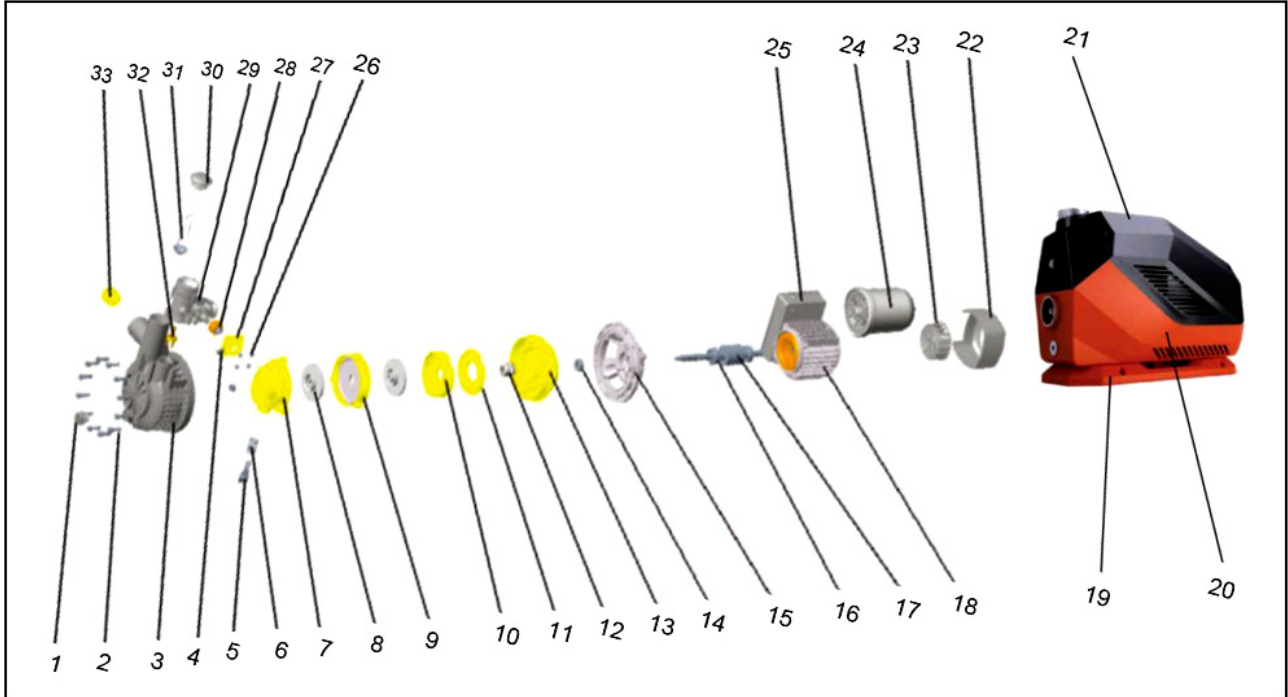

No.	Parts
1	Waterproof Screw
2	Screw
3	Pump Body
4	Converter
5	Check Valve
6	Spring
7	Suction Guide Vane
8	Pump Impeller
9	Diffuser
10	Diffuser
11	Seal Clamp
12	Mechanical Seal
13	Discharge System Guide
14	Nipple
15	Pump Clamp
16	Bearing
17	Motor Rotor

No.	Parts
18	Motor
19	Base
20	Housing
21	Cover
22	Fan Cover
23	Cooling Fan
24	Pressure Tank
25	Controller
26	Screw
27	Sensor Bracket
28	Transducer
29	5-Way Valve
30	Plug/Cap
31	Filter Screen/Strainer
32	Check Valve
33	Check Valve

Project	Project ID	Created by	Created on	Last update
---------	------------	------------	------------	-------------