



Technical Data

Multi Stage Pump - GARS-40/05

Revision no.

Page:
1

Receiver

From

Company name
Respons. Department
Person in charge
Phone number
Fax no
E-mail address



Brand: Gol Pumps
Model: GARS-40/05

Dimensions:

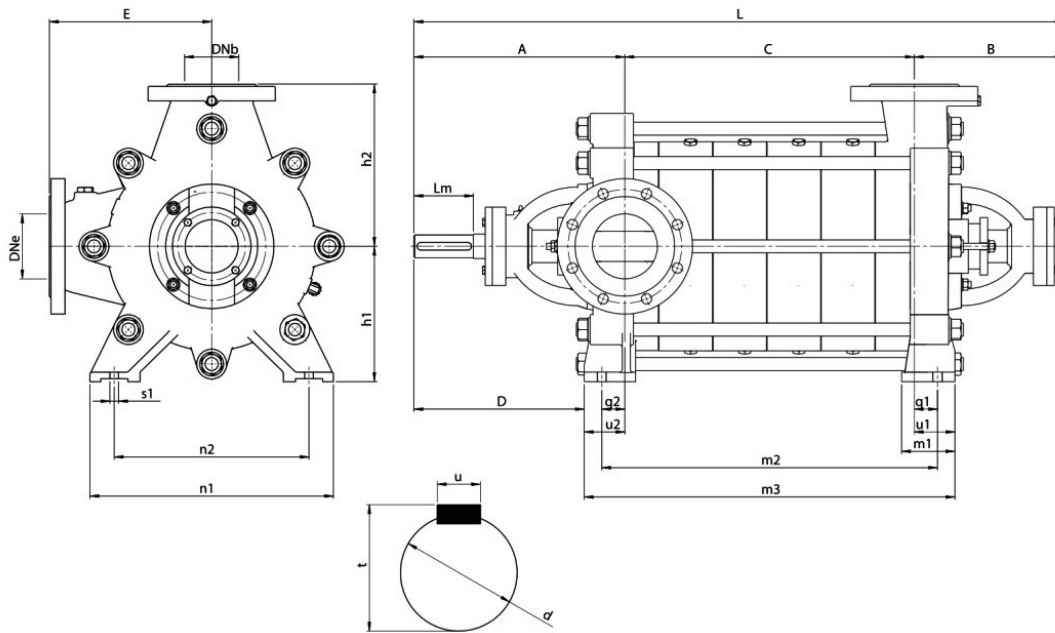

Inlet and Outlet Flange	
DNe	DNb
2	1.5

Shaft Dimensions (inch)			
d	Lm	t	u
0.9	2.4	1.1	0.3

Pump Installation Size (inch)																
A	B	D	E	L	h1	h2	q1	q2	u1	u2	m1	m2	m3	n1	n2	s1
9.5	6.3	5.2	6	C+15.9	5.2	6	3.1	3.4	4	4.3	2.4	C+5.8	C+8.3	7.6	5.3	0.6

"C" Dimensions by Stage (inch)																
2	3	4	5	6	7	8	9	10	11	12	13	14	15	16	17	
4.4	6.1	7.8	9.5	11.2	12.9	14.6	16.3	18	19.6	21.3	23	24.7	-	-	-	

Project	Project ID	Created by	Created on	Last update
---------	------------	------------	------------	-------------



Performance Curves

Multi Stage Pump - GARS-40/05

Revision no.

Page:

2

Receiver

From

 Company name
 Respons. Department
 Person in charge
 Phone number
 Fax no
 E-mail address

Pump (GGG40)		Motor	(PN 40)		EFF(0.65%)	Q 160	Power			
Type	Quantity Impeller	hp	DNe	DNb	Safe Motor Power (hp)	rpm	Head (ft)		Gal/m	
GARS-40/05	5	25.2	2	1.5	40	3600	Max.	836.6	Min.	44
		37.4	2	1.5		3600	Rate	721.8	Rate	132.1
		42.1	2	1.5		3600	Min.	459.3	Max.	211.3

ARS 40-05 (3600RPM)

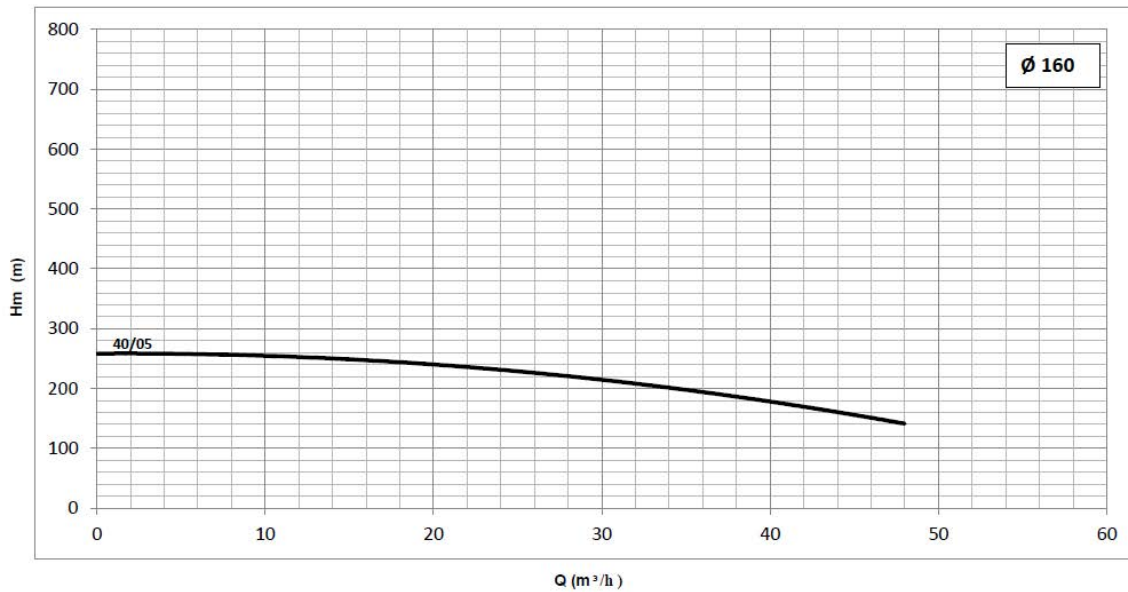

Parts List:

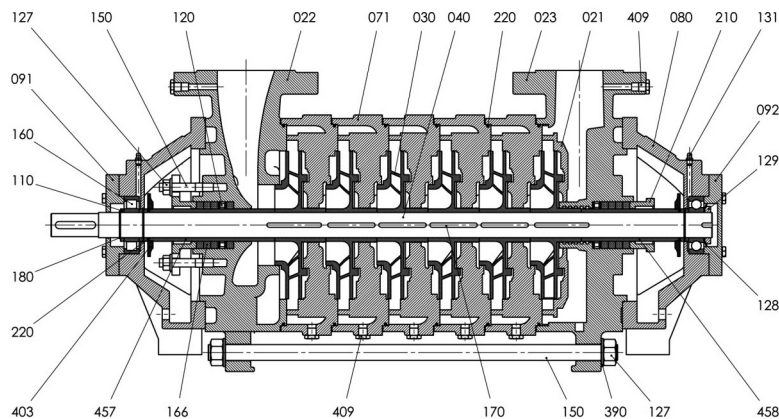

Discharge Diffuser	021
Suction Body	022
Discharge Body	023
Impeller	030
Shaft	040
Stage Body	071
Bearing Housing	080
Bearing Cover (Coupling)	091
Bearing Cover (Outside)	092
Bearing Setting Sleeve	110
Flushing Ring	120
Nut	127
Protection Sheet	128
Nut	129

Grease Nipple	131
Casing Tiebolt	150
Bearing	160
Soft Packing	166
Pin	170
Ring	180
Connection Support	210
O-Ring	220
Washer	390
Throw Protection	403
Bolt	409
Seal Sleeve (Suction)	457
Seal Sleeve (Discharge)	458

Project

Project ID

Created by

Created on

Last update