



Technical Data

Vertical Multistage - SBN 45-4

Revision no.

Page:
1

Receiver

From

Company name
Respons. Department
Person in charge
Phone number
Fax no
E-mail address



Brand: Gol Pumps
Model: SBN 45-4



Dimensions:

* The Flange (ANSI) 300lb is not included. If you wish, you have to select the option when adding the product to the cart.

Flange (DIN)
PN16-25-40 / DN80

* **Flange (ANSI)**
3" 300 lb.R.F.
Stages 4-1~8-1

Pump Installation Size (inch)						
DIN Flange		Port Size		D1	D2	Net Weight
H1	H2	DNA	DNM			Lb.
35.8	61.8	3	3	15.4	11.6	702.5

Project	Project ID	Created by	Created on	Last update
---------	------------	------------	------------	-------------



Performance Curves

Vertical Multistage - SBN 45-4

Revision no. _____

Page: 2

Receiver _____

From _____

Company name _____
 Respons. Department _____
 Person in charge _____
 Phone number _____
 Fax no _____
 E-mail address _____

Model	Port Size (in.)		Flow	HP	Volts	Amps	Phase	Max. Head	Max. Suction	Max. PSI
	DNA	DNM	GPH		V	I Max.	Ph	Ft.	Ft.	
SBN 45-4	3	3	19200	40	460	51.4	Three	485	17	215

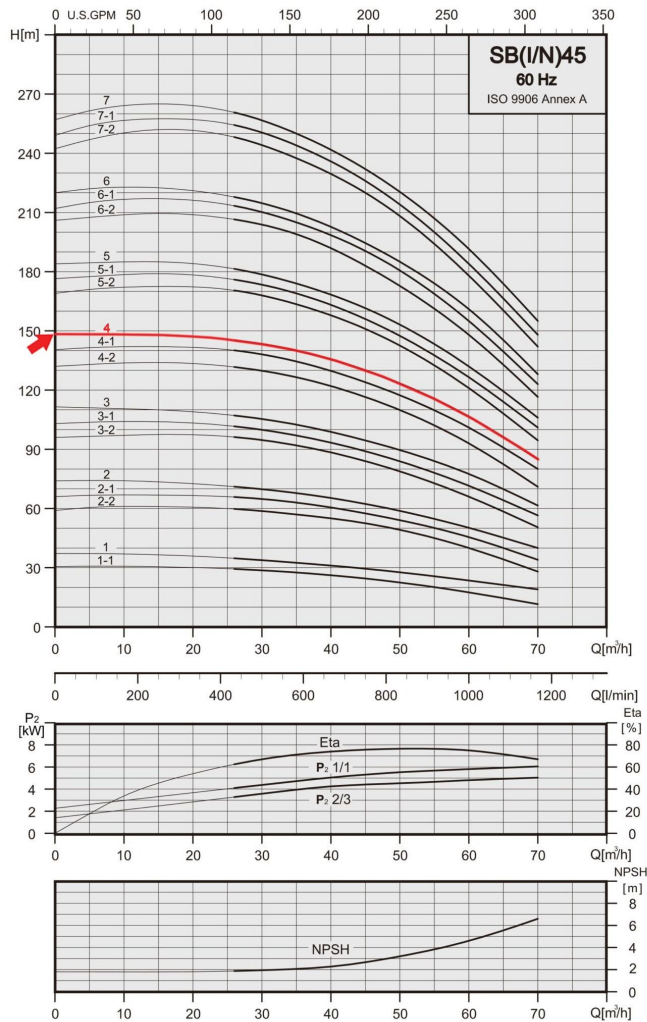

Project _____	Project ID _____	Created by _____	Created on _____	Last update _____
---------------	------------------	------------------	------------------	-------------------



Parts and Materials

Vertical Multistage - SBN 45-4

Revision no.

Page:
 3

Receiver

From

Company name
 Respons. Department
 Person in charge
 Phone number
 Fax no
 E-mail address

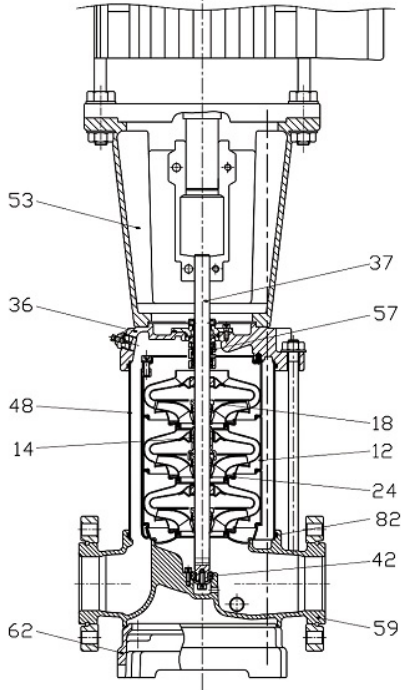

Parts List	Material	Standard
36 Pump Head	Stainless Steel	AISI 316
53 Motor Bracket	Cast Iron	ASTM 35B
18 Impeller	Stainless Steel	AISI 316
37 Shaft	Stainless Steel	AISI 316
48 Outer Sleeve	Stainless Steel	AISI 316
82 O-ring for Outer Sleeve	EPDM	
12 Chamber	Stainless Steel	AISI 316
24 Neck Ring	Carbon Fiber + POB + PTFE	
59 Base	Stainless Steel	AISI 316
62 Base Plate	Cast Iron	ASTM 35B
57 Mechanical Seal	Cartridge Type	
14 Bearing Ring	POB + Graphite + PTFE	
42 Bottom Bearing Ring	Tungsten Carbide	

Project	Project ID	Created by	Created on	Last update
---------	------------	------------	------------	-------------